

Surface Mount Schottky Barrier Rectifier

Reverse Voltage - 20 to 200 V

Forward Current - 3.0A

Features

- Metal silicon junction, majority carrier conduction
- For surface mounted applications
- Low power loss, high efficiency
- High forward surge current capability
- For use in low voltage, high frequency inverters, free wheeling, and polarity protection applications

MECHANICAL DATA

- Case: SMAF
- Terminals: Solderable per MIL-STD-750, Method 2026
- Approx. Weight: 27mg / 0.00095oz

PINNING

PIN	DESCRIPTION
1	Cathode
2	Anode

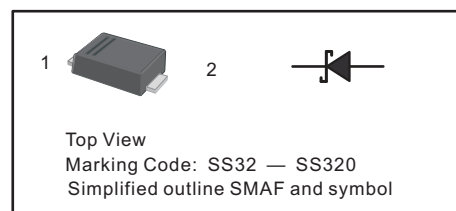

Absolute Maximum Ratings and Electrical characteristics

Ratings at 25 °C ambient temperature unless otherwise specified. Single phase, half wave, 60Hz resistive or inductive load, for capacitive load, derate by 20 %

Parameter	Symbols	SS32F	SS34F	SS34AF	SS36F	SS38F	SS310F	SS312F	SS315F	SS320F	Units
Maximum Repetitive Peak Reverse Voltage	V_{RRM}	20	40	45	60	80	100	120	150	200	V
Maximum RMS voltage	V_{RMS}	14	28	31.5	42	56	70	84	105	140	V
Maximum DC Blocking Voltage	V_{DC}	20	40	45	60	80	100	120	150	200	V
Maximum Average Forward Rectified Current	$I_{F(AV)}$	3.0									A
Peak Forward Surge Current, 8.3ms Single Half Sine-wave Superimposed on Rated Load (JEDEC method)	I_{FSM}	80									A
Max Instantaneous Forward Voltage at 3 A	V_F	0.55	0.70			0.85	0.95				V
Maximum DC Reverse Current $T_a = 25^\circ\text{C}$ at Rated DC Reverse Voltage $T_a = 100^\circ\text{C}$	I_R	0.5 5				0.3 3					mA
Typical Junction Capacitance ⁽¹⁾	C_j	250				180					pF
Typical Thermal Resistance ⁽²⁾	$R_{\theta JA}$ $R_{\theta JC}$	70 18									$^\circ\text{C/W}$
Operating Junction Temperature Range	T_j	-55 ~ +125									$^\circ\text{C}$
Storage Temperature Range	T_{stg}	-55 ~ +150									$^\circ\text{C}$

(1) Measured at 1 MHz and applied reverse voltage of 4 V D.C

(2) P.C.B. mounted with 2.0" X 2.0" (5 X 5 cm) copper pad areas.

Fig.1 Forward Current Derating Curve

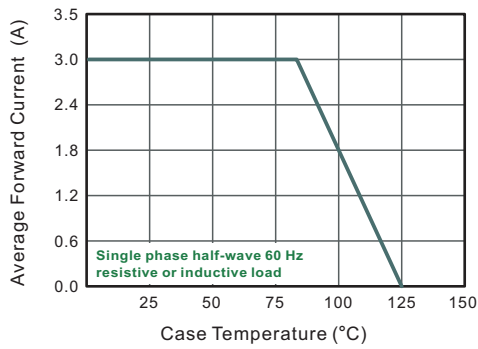

Fig.2 Typical Reverse Characteristics

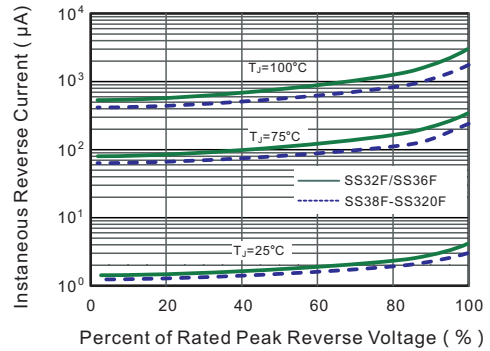

Fig.3 Typical Forward Characteristic

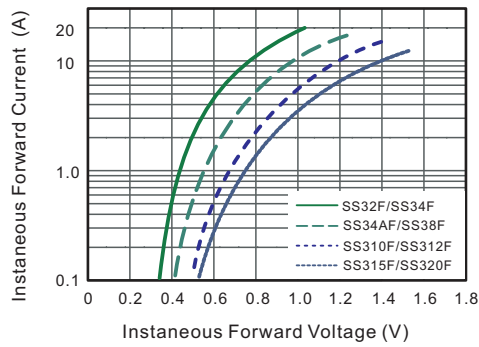

Fig.4 Typical Junction Capacitance

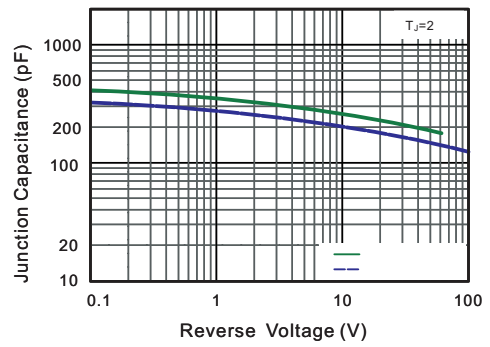

Fig.5 Maximum Non-Repetitive Peak Forward Surge Current

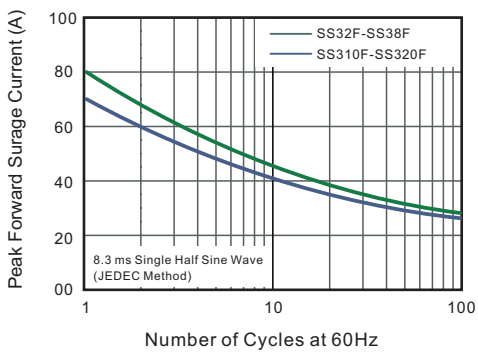
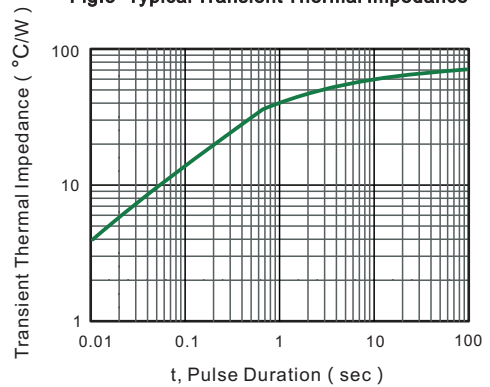

Fig.5- Typical Transient Thermal Impedance



PACKAGE OUTLINE

Plastic surface mounted package; 2 leads

SMAF

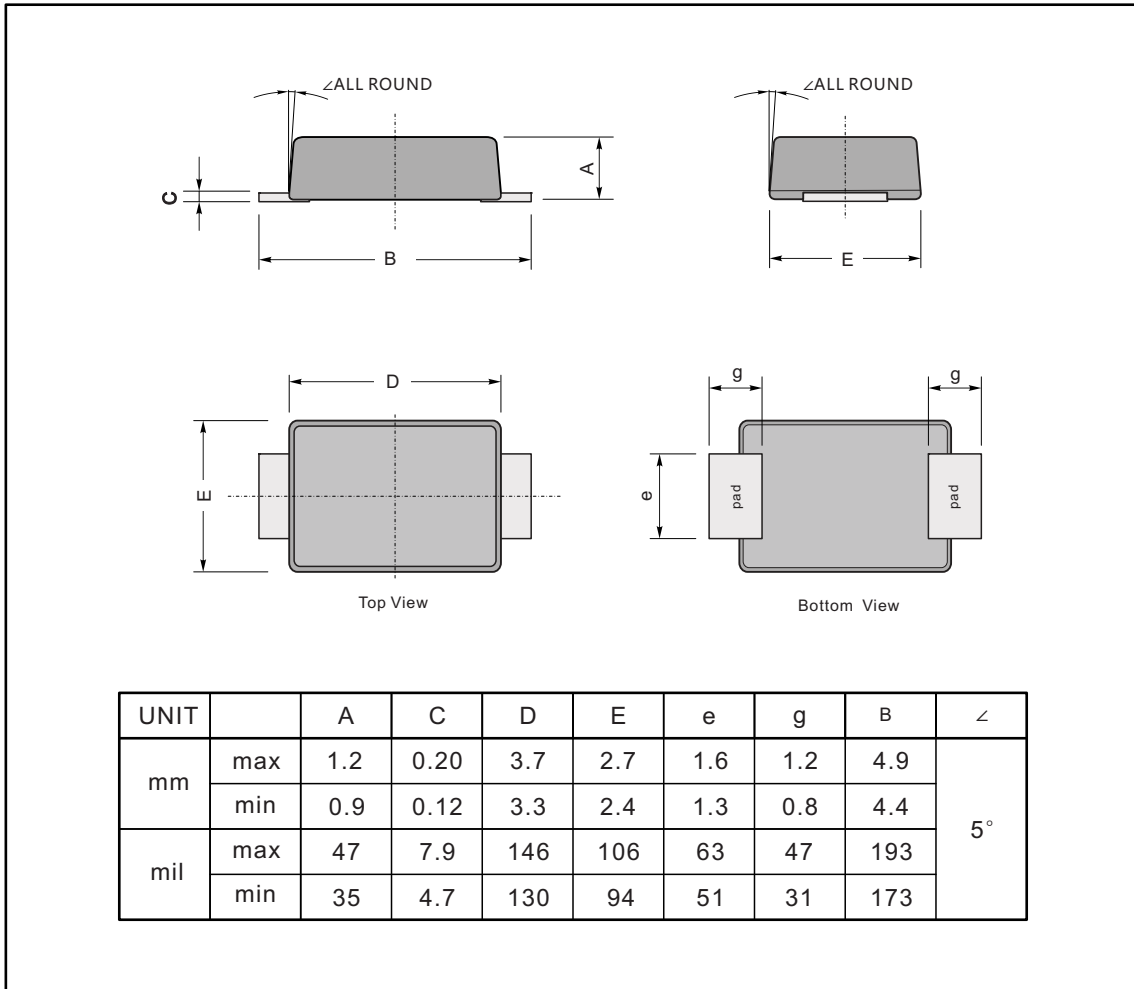

The recommended mounting pad size

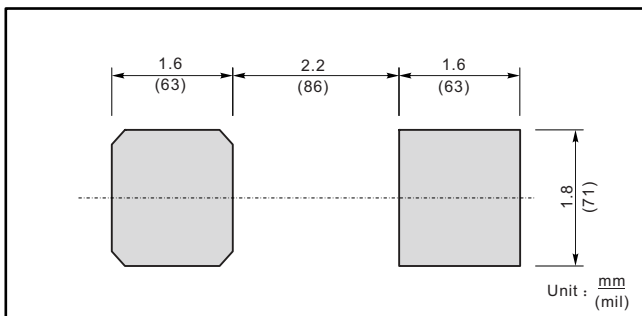

Marking

Type number	Marking code
SS32F	SS32
SS34F	SS34
SS34AF	SS34A
SS36F	SS36
SS38F	SS38
SS310F	SS310
SS312F	SS312
SS315F	SS315
SS320F	SS320