

DIO1634

2:1 MIPI 6 GHz 4-Data Lane & 1-CLK Lane Switch

Features

- Supply voltage range: 1.65 V to 5 V
- Input signals: 0 V to 5 V
- Data rate support: up to 3.5 Gbps C-PHY, up to 4.5 Gb/s D-PHY
- DIFF BW: 6 GHz
- Switch type: SPDT (10 channels)
- Signal types: D-PHY and C-PHY
- R_{ON} : 7.5 Ω typical HS MIPI
8.4 Ω typical LP MIPI
- I_{CCZ} : 0.5 μ A (max.)
- I_{CC} : 26 μ A (typ.)
- O_{IRR} : -25 dB (typ.)
- X_{TALK} : -30 dB (typ.)
- C_{ON} : 1.7 pF (typ.)
- Operating temperature: -40 to 85°C
- Package: 36-ball WLCSP

Descriptions

The DIO1634 is a single pole double throw (SPDT) switch which can be used as a 4-data lane & 1-CLK lane D-PHY or 3-data lane C-PHY MIPI switch. This switch can be used for switching high speed signal between MIPI sources and MIPI devices.

The DIO1634 has 10 channels and high bandwidth of 6 GHz. The DIO1634 has low power consumption, so it is a good choice for low power applications.

The DIO1634 is designed for the MIPI specification and allows connection to CSI / DSI, C-PHY / D-PHY module.

Applications

- Cellular phones, smart phones
- Display devices
- Tablets
- Portable devices

Typical Application

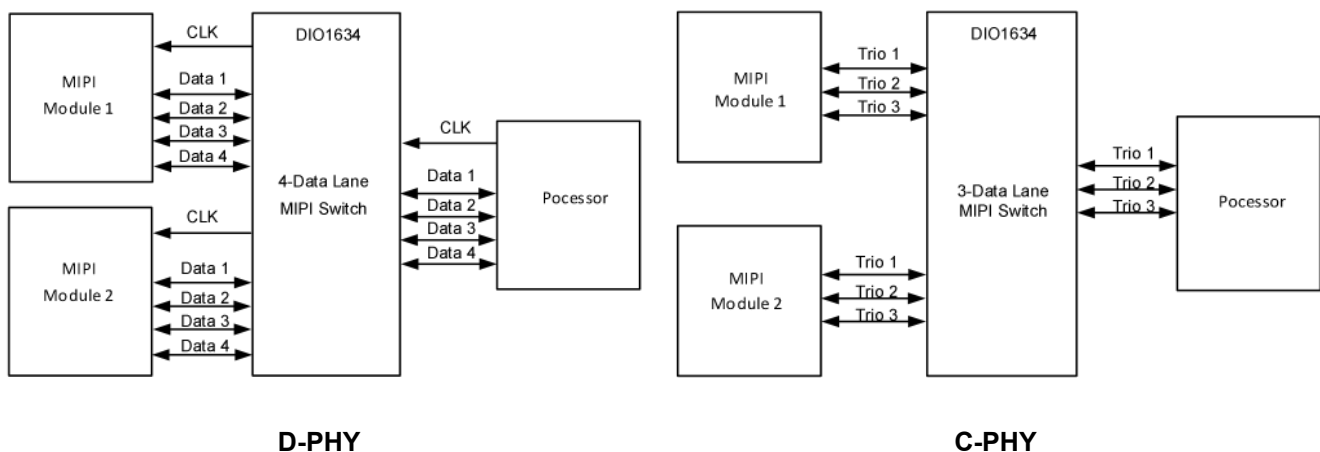

Figure 1. Typical D-PHY / C-PHY application

Ordering Information

Ordering Part No.	Top Marking	MSL	RoHS	T _A	Package	
DIO1634WL36	DR3D	1	Green	-40 to 85°C	WLCSP-36	Tape & Reel, 3000

Pin Descriptions

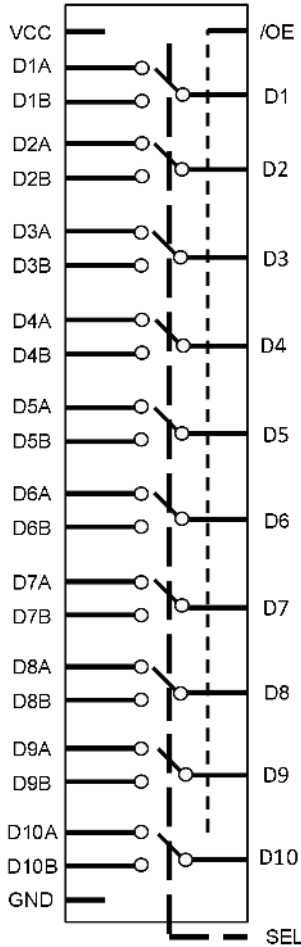

Figure 2. Analog symbol

Pin Name	Description		
Dn	Common clock path		
DnA	Common data path A		
DnB	Common data path B		
SEL	Control pin	SEL = 0	Dn = DnA
		SEL = 1	Dn = DnB
/OE	Output enable		
VCC	Power		
GND	Ground		

Pin Definitions

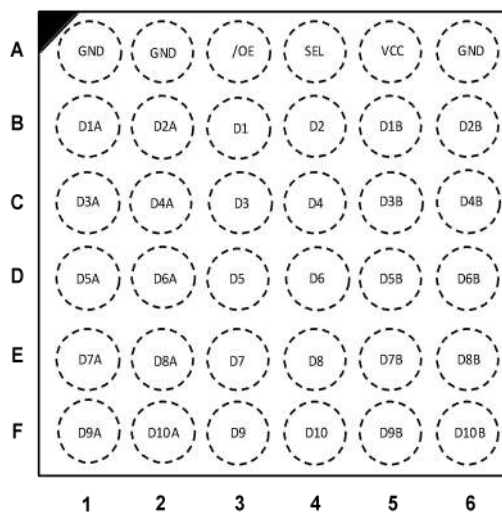

Figure 3. Top through view

Ball	Pin Name	Ball	Pin Name
A1	GND	D1	D5A
A2	GND	D2	D6A
A3	/OE	D3	D5
A4	SEL	D4	D6
A5	VCC	D5	D5B
A6	GND	D6	D6B
B1	D1A	E1	D7A
B2	D2A	E2	D8A
B3	D1	E3	D7
B4	D2	E4	D8
B5	D1B	E5	D7B
B6	D2B	E6	D8B
C1	D3A	F1	D9A
C2	D4A	F2	D10A
C3	D3	F3	D9
C4	D4	F4	D10
C5	D3B	F5	D9B
C6	D4B	F6	D10B



DIO1634

2:1 MIPI 6 GHz 4-data Lane & 1-clk Switch

Table 1. Truth table

SEL	/OE	Function
LOW	LOW	Dn = DnA
HIGH	LOW	Dn = DnB
X	HIGH	All ports high impedance

Absolute Maximum Ratings

Stresses beyond those listed under “Absolute Maximum Rating” may cause permanent damage to the device. These are stress ratings only and functional operation of the device at these or any other condition beyond those indicated in the operational sections of the specifications is not implied. Exposure to absolute maximum rating conditions for extended periods may affect device reliability.

Symbol	Parameter	Ratings	Unit
V _{CC}	Supply voltage	-0.5 to 6	V
V _{CNTRL}	DC input voltage	-0.5 to 6	V
V _{SW}	DC switch I/O voltage ⁽¹⁾	-0.5 to 6	V
I _{OUT}	DC output current	Up to 25	mA
T _{STG}	Storage temperature	-65 to 150	°C
ESD	HBM (JEDEC EIA/JESD22-A114F for all pins)	±3.5	kV

Note:

(1) V_{SW} refers to analog data switch paths.

Recommended Operating Conditions

The Recommended Operating Conditions table defines the conditions for actual device operation. Recommended Operating conditions are specified to ensure optimal performance to the datasheet specifications. DIOO does not Recommend exceeding them or designing to Absolute Maximum Ratings.

Symbol	Parameter	Min	Max	Unit	
V _{CC}	Supply voltage	1.65	5.0	V	
V _{CNTRL}	Control input voltage (SEL, /OE) ⁽¹⁾	0	V _{CC}	V	
V _{SW}	Switch I/O voltage (Dn, DnA, DnB)	HS mode	0	5	V
		LP mode	0	5	
T _A	Operating temperature	-40	85	°C	

Note:

(1) The control input must be held High or Low; it must not float.

DC Electrical Characteristics

Typical values are at $T_A = 25^\circ\text{C}$, unless otherwise specified.

Symbol	Parameter	Test Conditions	V_{CC} (V)	Min	Typ	Max	Unit
V_{IH}	Input voltage high	SEL, /OE at $T_A = 25^\circ\text{C}$	1.65	0.95			V
			5.0	1.35			
V_{IL}	Input voltage low	SEL, /OE at $T_A = 25^\circ\text{C}$	1.65			0.4	V
			5.0			0.4	
I_{IN}	Control input leakage (SEL, /OE)	$V_{CNTRL} = 0$ to V_{CC} , $T_A = 25^\circ\text{C}$	5.0			0.5	μA
$I_{NO(OFF)}, I_{NC(OFF)}$	Off leakage current of ports (Dn, DnA, DnB)	$0\text{ V} \leq V_{SW} \leq 1.3\text{ V}$, $T_A = 25^\circ\text{C}$	5.0	-0.5		0.5	μA
$I_{A(ON)}$	On leakage current of common ports (Dn)	$0\text{ V} \leq V_{SW} \leq 1.3\text{ V}$, $T_A = 25^\circ\text{C}$	5.0	-0.5		0.5	μA
I_{OFF}	Power-off leakage current	$0\text{ V} \leq V_{SW} \leq 1.3\text{ V}$, $T_A = 25^\circ\text{C}$	0.0	-0.5		0.5	μA
I_{OZ}	Off-state leakage, /OE = high	$0\text{ V} \leq V_{SW} \leq 1.3\text{ V}$, $T_A = 25^\circ\text{C}$	5.0	-0.5		0.5	μA
$R_{ON_MIPI_HS}$	Switch on resistance for HS MIPI applications ⁽¹⁾	$I_{ON} = -8\text{ mA}$, /OE = 0 V, SEL = V_{CC} or 0 V, $T_A = 25^\circ\text{C}$, $V_{SW} = 0.2\text{ V}$	1.65		7.5	10	Ω
			5.0				
$R_{ON_MIPI_LP}$	Switch on resistance for LP MIPI applications ⁽¹⁾	$I_{ON} = -8\text{ mA}$, /OE = 0 V, SEL = V_{CC} or 0 V, $T_A = 25^\circ\text{C}$, $V_{SW} = 1.2\text{ V}$	1.65		8.4	11	Ω
			5.0				
$\Delta R_{ON_MIPI_HS}$	On resistance matching between HS MIPI channels ⁽¹⁾	$I_{ON} = -8\text{ mA}$, /OE = 0 V, SEL = V_{CC} or 0 V, $V_{SW} = 0.2\text{ V}$	1.65		0.2		Ω
			5.0				
$\Delta R_{ON_MIPI_LP}$	On resistance matching between LP MIPI channels ⁽¹⁾	$I_{ON} = -8\text{ mA}$, /OE = 0 V, SEL = V_{CC} or 0 V, $V_{SW} = 1.2\text{ V}$	1.65		0.2		Ω
			5.0				
$R_{ON_FLAT_MIPI_HS}$	On resistance flatness for HS MIPI signals ⁽¹⁾	$I_{ON} = -8\text{ mA}$, /OE = 0 V, SEL = V_{CC} or 0 V, $0.1\text{ V} \leq V_{SW} \leq 0.3\text{ V}$	1.65		1.1		Ω
			5.0				
$R_{ON_FLAT_MIPI_LP}$	On resistance flatness for LP MIPI signals ⁽¹⁾	$I_{ON} = -8\text{ mA}$, /OE = 0 V, SEL = V_{CC} or 0 V, $0\text{ V} \leq V_{SW} \leq 1.3\text{ V}$	1.65		0.4		Ω
			5.0				
I_{CCZ}	Quiescent Hi-Z supply current	SEL = V_{CC} or 0 V, $I_{OUT} = 0$, /OE = V_{CC} , $T_A = 25^\circ\text{C}$	5			0.5	μA
I_{CC}	Quiescent supply current	SEL = V_{CC} or 0 V, $I_{OUT} = 0$, /OE = 0, $T_A = 25^\circ\text{C}$	5		26	35	μA
I_{CCT}	Increase in I_{CC} current per control voltage and V_{CC}	SEL = V_{CC} or 0 V, /OE = 1.65 V, $T_A = 25^\circ\text{C}$	5			1	μA

Note:

- (1) Measured by the voltage drop between A and B pins at the indicated current through the switch. On resistance is determined by the lower of the voltage on the two (A or B ports).
- (2) Specifications subject to change without notice.

AC Electrical Characteristics

All typical values are for $V_{CC} = 3.3\text{ V}$ at $T_A = 25^\circ\text{C}$, unless otherwise specified.

Symbol	Parameter	Test Conditions	V_{CC} (V)	Min	Typ	Max	Unit
t_{INIT}	Initialization time V_{CC} to output	$R_L = 50\ \Omega$, $V_{SW} = 0.6\text{ V}$	3.3		40		μs
t_{EN}	Enable turn-on time, /OE to output	$R_L = 50\ \Omega$, $V_{SW} = 0.6\text{ V}$	3.3		40		μs
t_{DIS}	Disable turn-off time, /OE to output	$R_L = 50\ \Omega$, $V_{SW} = 0.6\text{ V}$	3.3		50		ns
t_{ON}	Turn-on time, SEL to output	$R_L = 50\ \Omega$, $V_{SW} = 0.6\text{ V}$	3.3		880		ns
t_{OFF}	Turn-off time, SEL to output	$R_L = 50\ \Omega$, $V_{SW} = 0.6\text{ V}$	3.3		60		ns
t_{BBM}	Break-before-make time	$R_L = 50\ \Omega$, $V_{SW} = 0.6\text{ V}$	3.3		320		ns
O_{IRR}	Off isolation for MIPI ⁽¹⁾	$R_L = 50\ \Omega$, $f = 1250\text{ MHz}$, /OE = High, $V_{SW} = 0.2\text{ V}_{PP}$	1.8		-25		dB
BW	-3 dB differential bandwidth ⁽¹⁾	$R_L = 50\ \Omega$, $C_L = 0\text{ pF}$, $V_{SW} = 0.2\text{ V}_{PP}$	1.8		6		GHz
X_{TALK}	Crosstalk for MIPI ⁽¹⁾	$R_L = 50\ \Omega$, $f = 1250\text{ MHz}$, SEL = High, $V_{SW} = 0.2\text{ V}_{PP}$	3.3		-30		dB
		$R_L = 50\ \Omega$, $f = 1250\text{ MHz}$, SEL = Low, $V_{SW} = 0.2\text{ V}_{PP}$			-30		

Note:

- (1) Guaranteed by characterization.
- (2) Specifications subject to change without notice.

Capacitance

Symbol	Parameter	Conditions	Min	Typ	Max	Unit
C_{ON}	On capacitance	$V_{CC} = 3.3\text{ V}$, /OE = 0 V, $f = 1250\text{ MHz}$		1.7		pF

Note:

- (1) Specifications subject to change without notice.

Typical Performance Characteristics

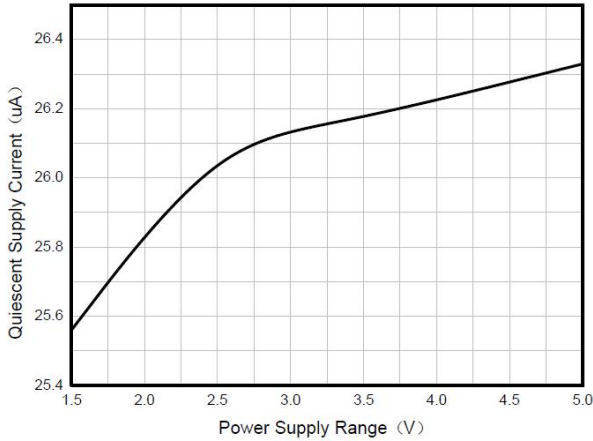

Figure 4. Quiescent supply current

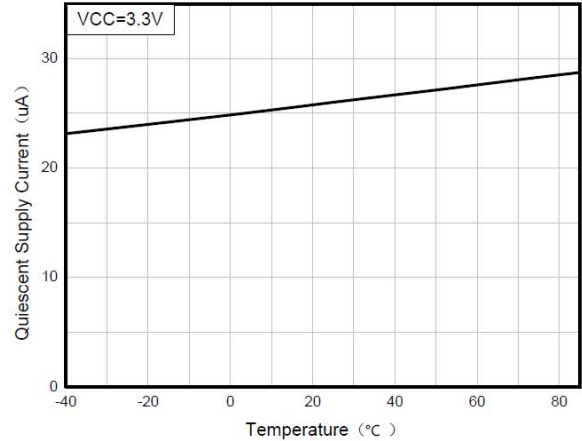

Figure 5. Quiescent supply current vs. Temperature

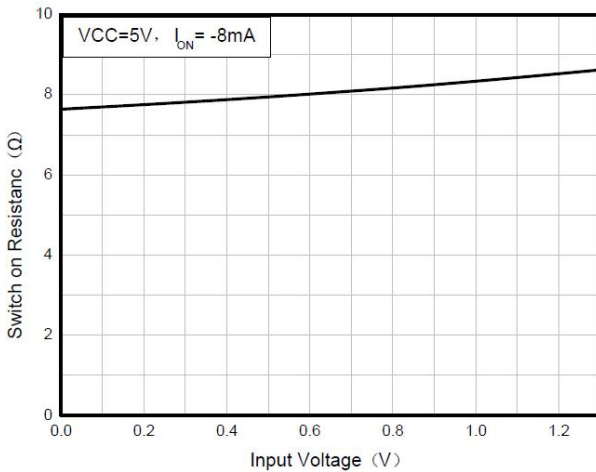

Figure 6. Switch on resistance vs. Input voltage

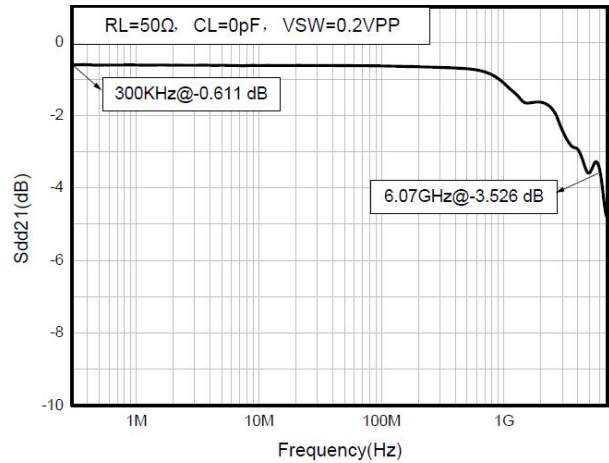

Figure 7. Differential -3 dB bandwidth

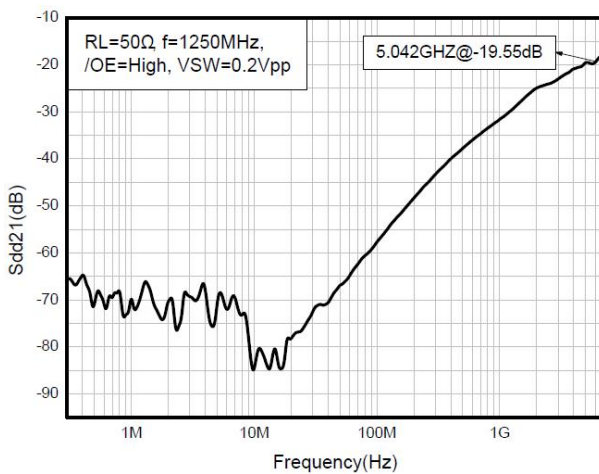
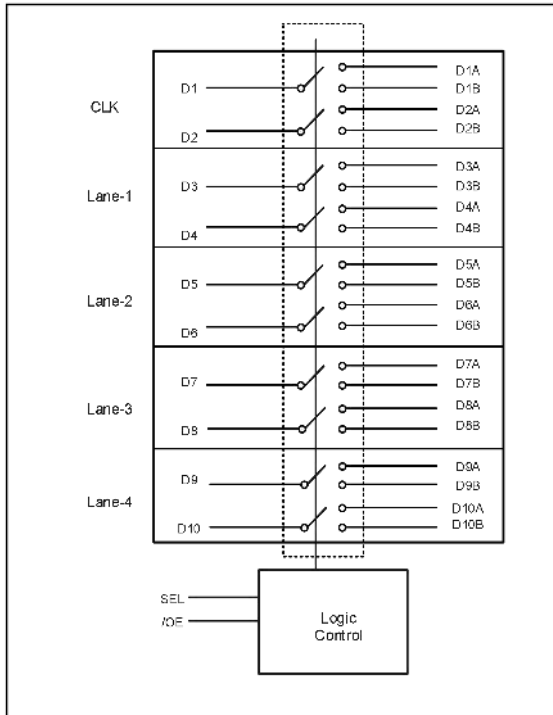
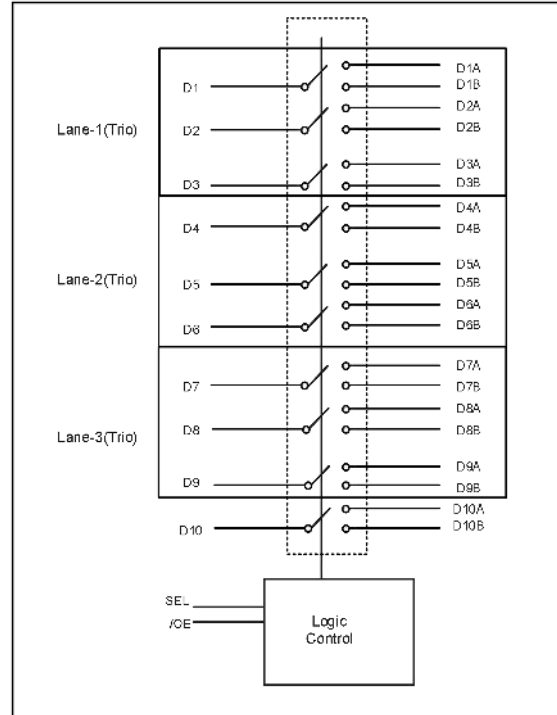

Figure 8. Differential off isolation

Block Diagram



D-PHY



C-PHY

Physical Dimensions: WLCSP-36 (0.35 mm pitch)

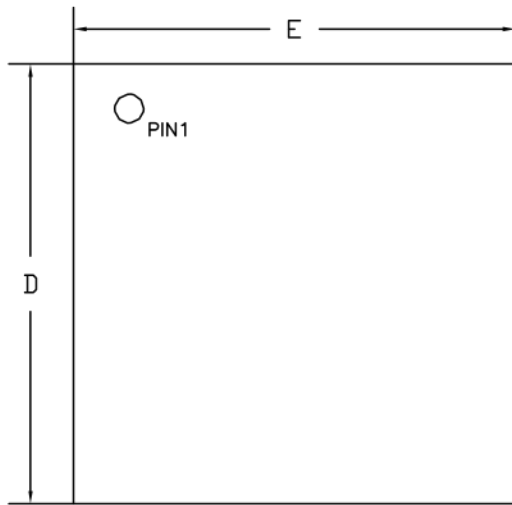

TOP VIEW
(MARK SIDE)

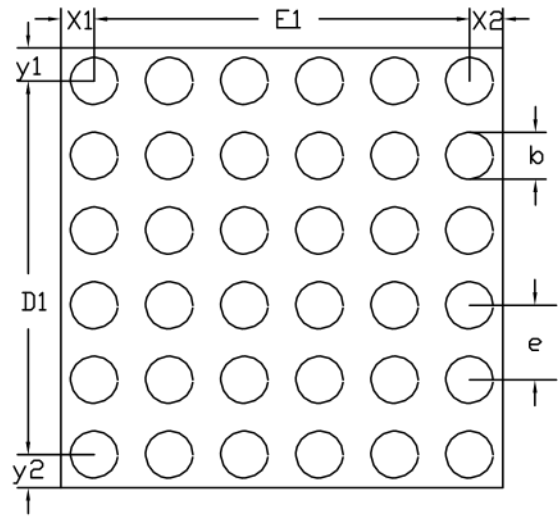

BOTTOM VIEW
(BALL SIDE)

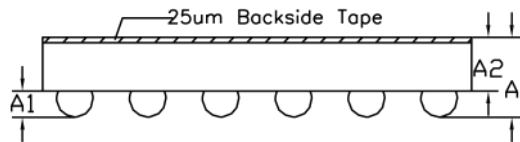

SIDE VIEW

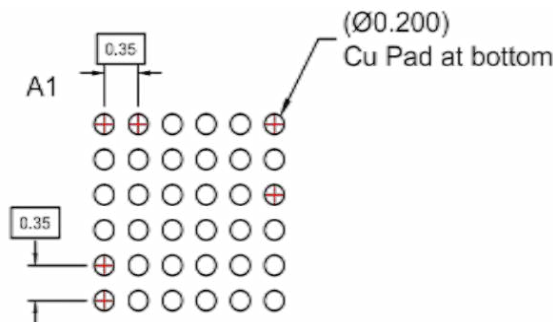

Recommended Land Pattern

Common Dimensions (Units of measure = Millimeter)			
Symbol	Min	Nom	Max
A	0.391	0.432	0.473
A1	0.130	0.150	0.170
A2	0.261	0.282	0.303
D	2.030	2.060	2.090
D1	1.750 BSC		
E	2.030	2.060	2.090
E1	1.750 BSC		
b	0.197	0.217	0.237
e	0.350 BSC		
x1	0.155 REF		
x2	0.155 REF		
y1	0.155 REF		
y2	0.155 REF		



DIO1634

2:1 MIPI 6 GHz 4-data Lane & 1-clk Switch

CONTACT US

Dioo is a professional design and sales corporation for high-quality and performance analog semiconductors. The company focuses on industry markets, such as, cell phone, handheld products, laptop, and medical equipment and so on. Dioo's product families include analog signal processing and amplifying, LED drivers and charger IC. Go to <http://www.dioo.com> for a complete list of Dioo product families.

For additional product information, or full datasheet, please contact with our sales department or representatives.