

Sensitivity Wavelength Range: 250-1100nm

The MT03-083 is a square (3.87mm x 3.87mm) 15mm² active area Silicon Photodiode in a hermetic TO-5 metal can package with a UV transmitting glass window. It is optimized for applications requiring high sensitivity in the 300 to 560nm region (UVA, Blue & Green).

Features

- > Low Noise
- > High Speed
- > Wide Dynamic Range
- > 365nm & Blue/Green Enhanced

Applications

- > Flame Detection
- > Currency Authentication
- > Spectroscopy Equipment
- > Fluorescence

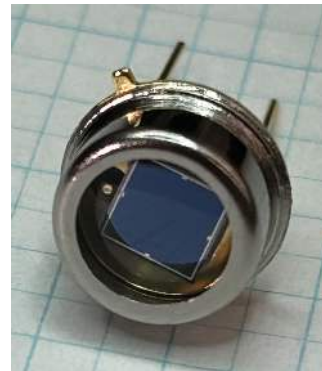

Absolute Maximum Ratings

Items	Symbol	Rating	Unit
Reverse Voltage	V _R	50	V
Operating Temperature Range	T _{opr}	-40 ~ +100	°C
Storage Temperature Range	T _{stg}	-55 ~ +125	°C
Lead Soldering Temperature*1	T _{ls}	260	°C



*1: Time 5 Sec max, Position: Up to 3mm from the body.

Electrical & Optical Characteristics (T_a = 23°C)

Items	Symbol	Conditions	MIN	TYP	MAX	Unit
Dark Current	I _d	V _R =5V	--	0.5	2.0	nA
Breakdown Voltage	V(BR)	I _R =10μA	50	--	--	V
Spectral Sensitivity	λ	--	--	250-1100	--	nm
Peak Sensitivity Wavelength	λ _p	--	--	950	--	nm
Responsivity	R	V _R =0V, λ=365nm	--	0.21	--	A/W
Responsivity	R	V _R =0V, λ=633nm	--	0.40	--	A/W
Response Time @635nm	T _r	R _L =50Ω, V _R =5V	--	25	--	ns
Junction Capacitance	C _j	@ 1MHz, V _R =0V	--	190	--	pF
Junction Capacitance	C _j	@ 1MHz, V _R =5V	--	65	80	pF
Shunt Resistance	R _{sh}	V _R =10mV	100	200	--	MΩ

2024-07

TO-5 Package Dimensions (2 Pin)

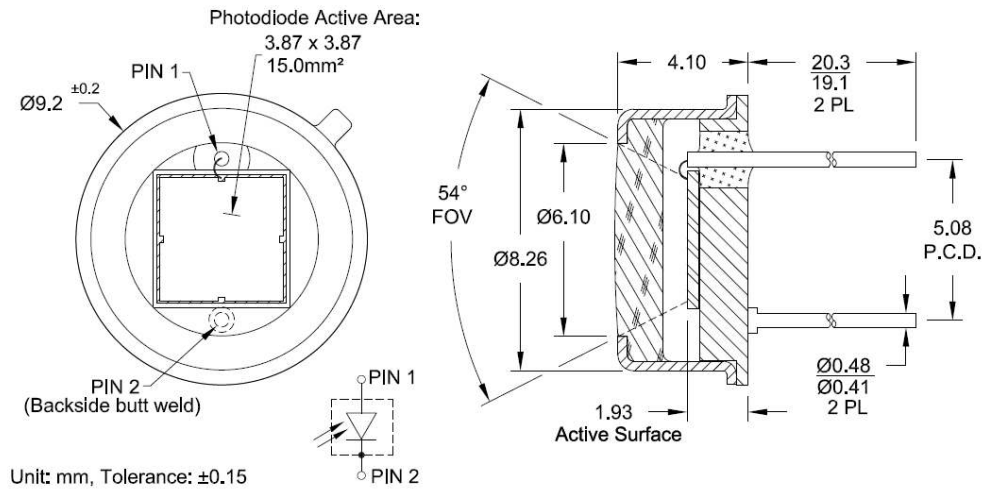

Capacitance vs Reverse Bias

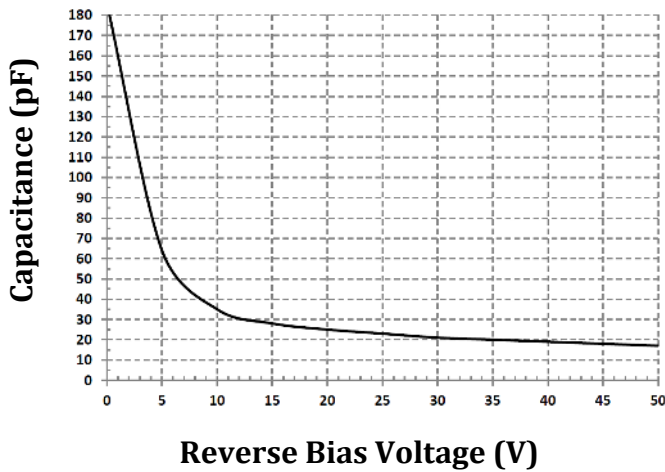

Dark Current vs Reverse Bias (23°C)

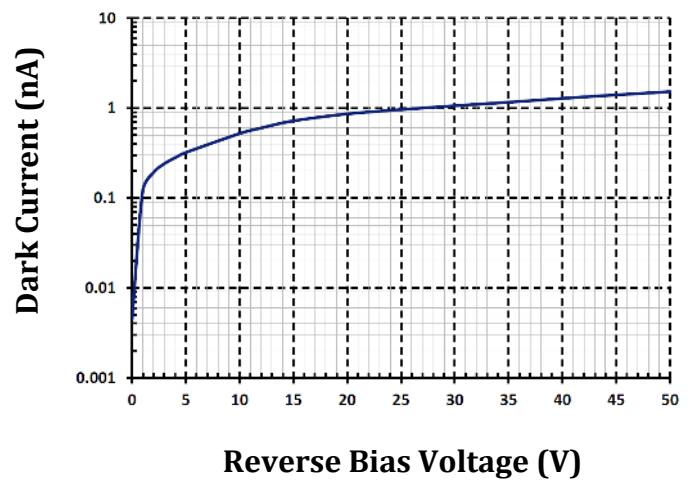

Dark Current vs Temperature ($V_r=5V$)

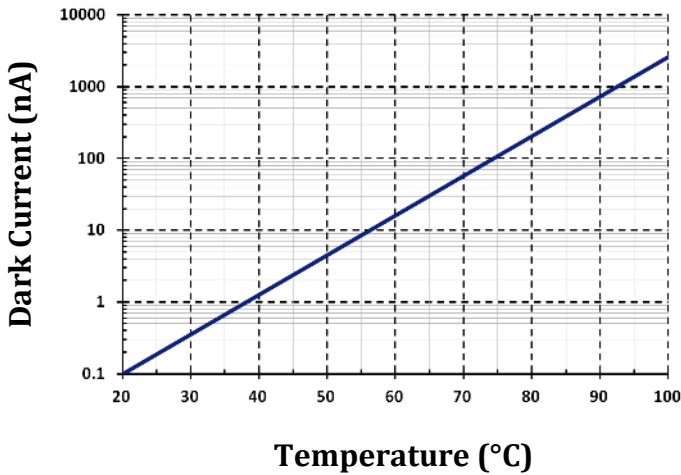

Series 4 Quantum Efficiency (23°C)

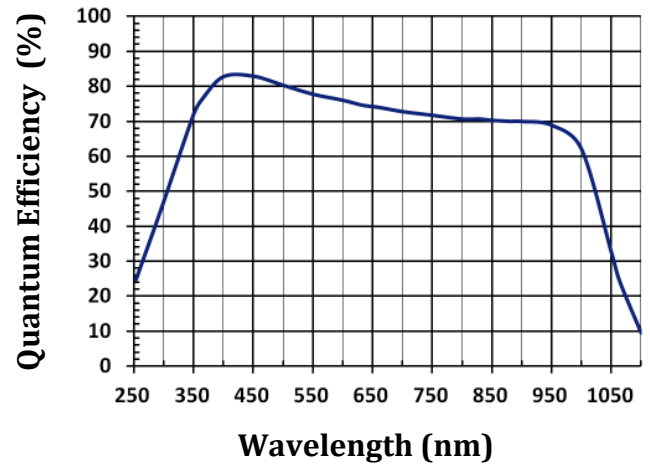

Photodiode Responsivity by Series

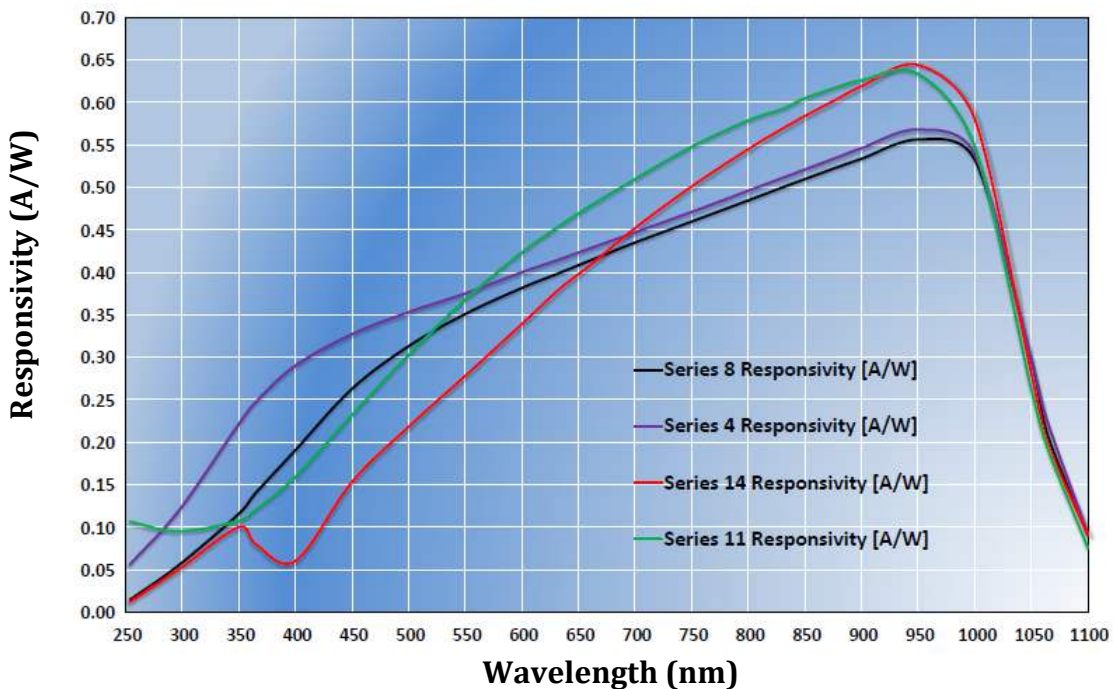

The information contained herein is subject to change without notice. Graphs display typical data that should not be used to create or extrapolate minimum and/or maximum device specifications.

2024-07